

ASSEMBLY INSTRUCTION

GA-MS003

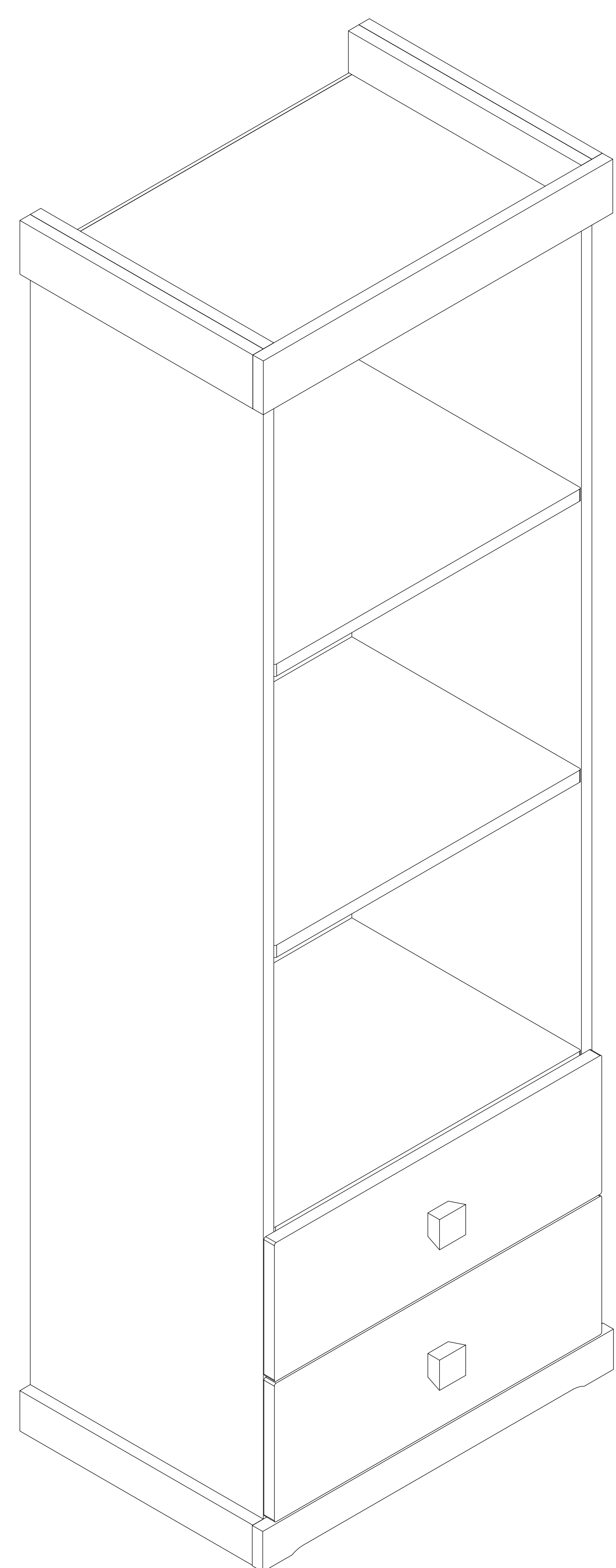
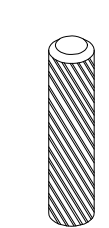
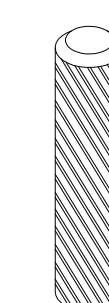
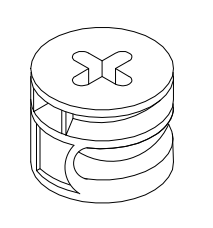
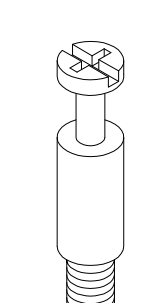
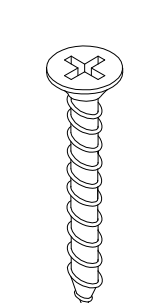
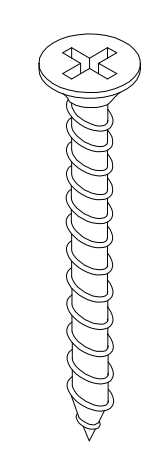
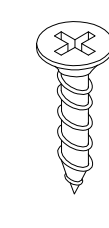
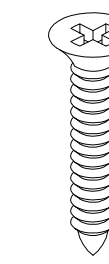
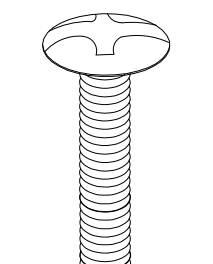
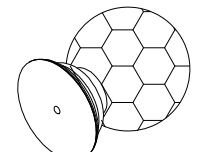
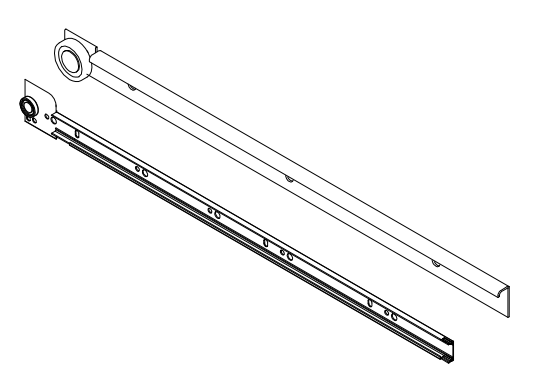

PLEASE CHECK THE HARDWARE LIKE THIS:

1#  φ6*20mm 4PCS	2#  φ8*40mm 10PCS	3#  φ15*12mm 36PCS	4#  φ7*45mm 36PCS	5#  8# φ4*30mm 2PCS	6#  8# φ4*40mm 8PCS
7#  7# φ3.5*16mm 44PCS	8#  7# φ3.5*25mm 20PCS	9#  φ4*20mm 2PCS	10#  φ30*38mm 2PCS	11#  12" 2SETS	

ALL THE PARTS AS BELOW:

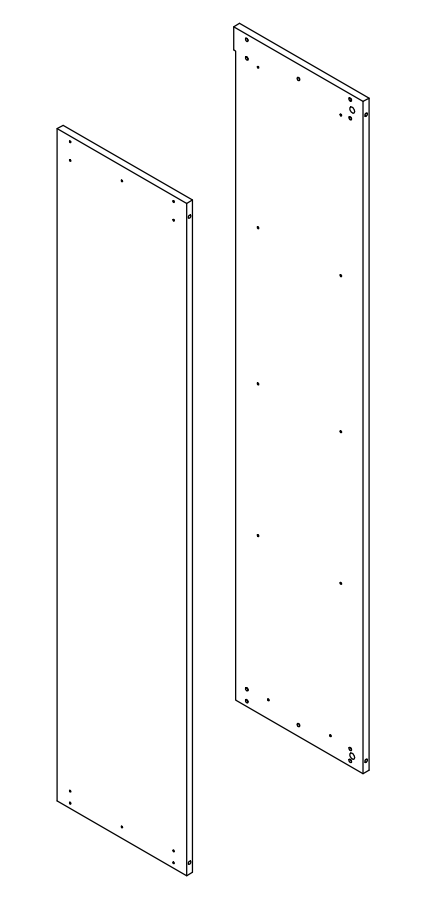
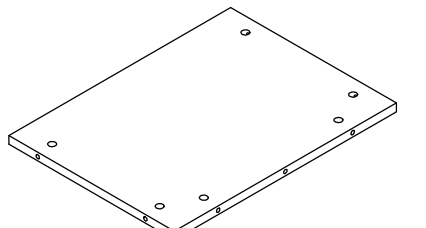
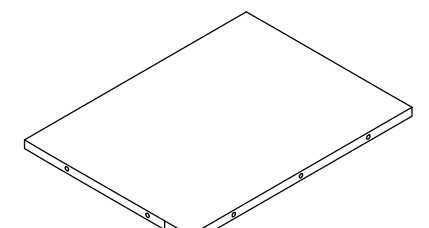
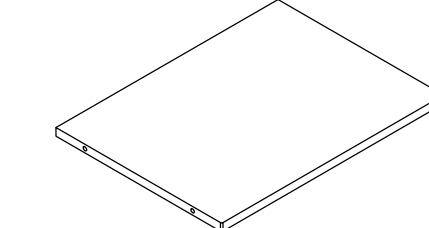
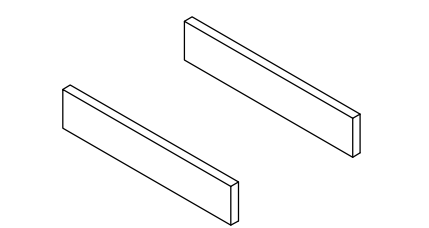
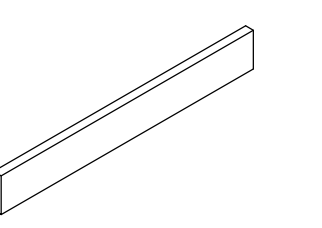
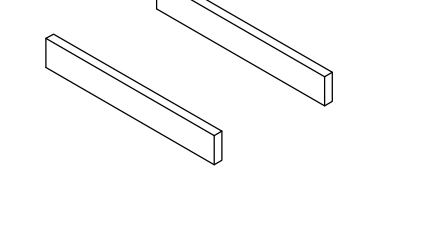
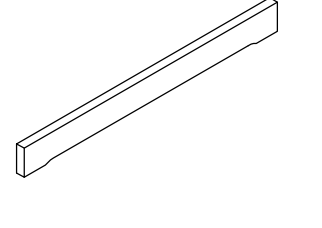
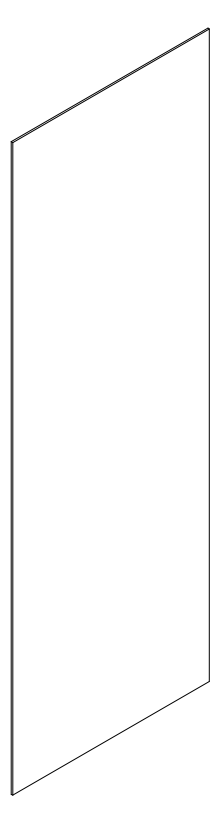
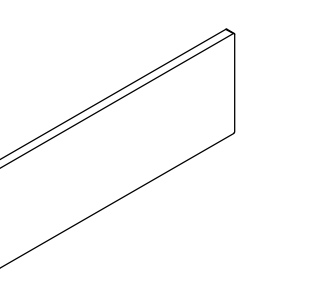
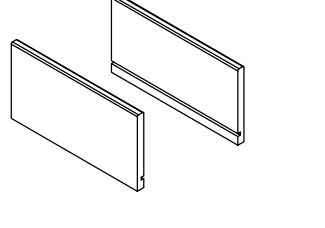
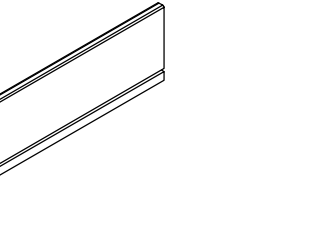
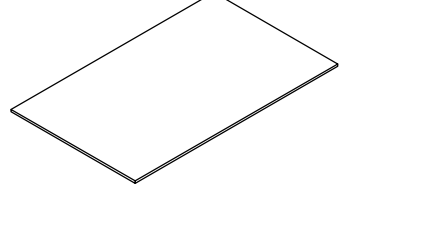
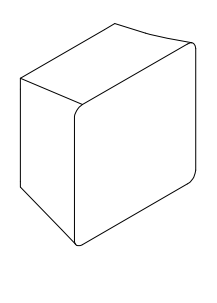
A  2PCS	B  1PC	C  1PC	D  3PCS	E  2PCS	F  1PC
G  2PCS	H  1PC	I  1PC	J  2PCS	K  4PCS	L  2PCS
M  2PCS	N  2PCS				

1

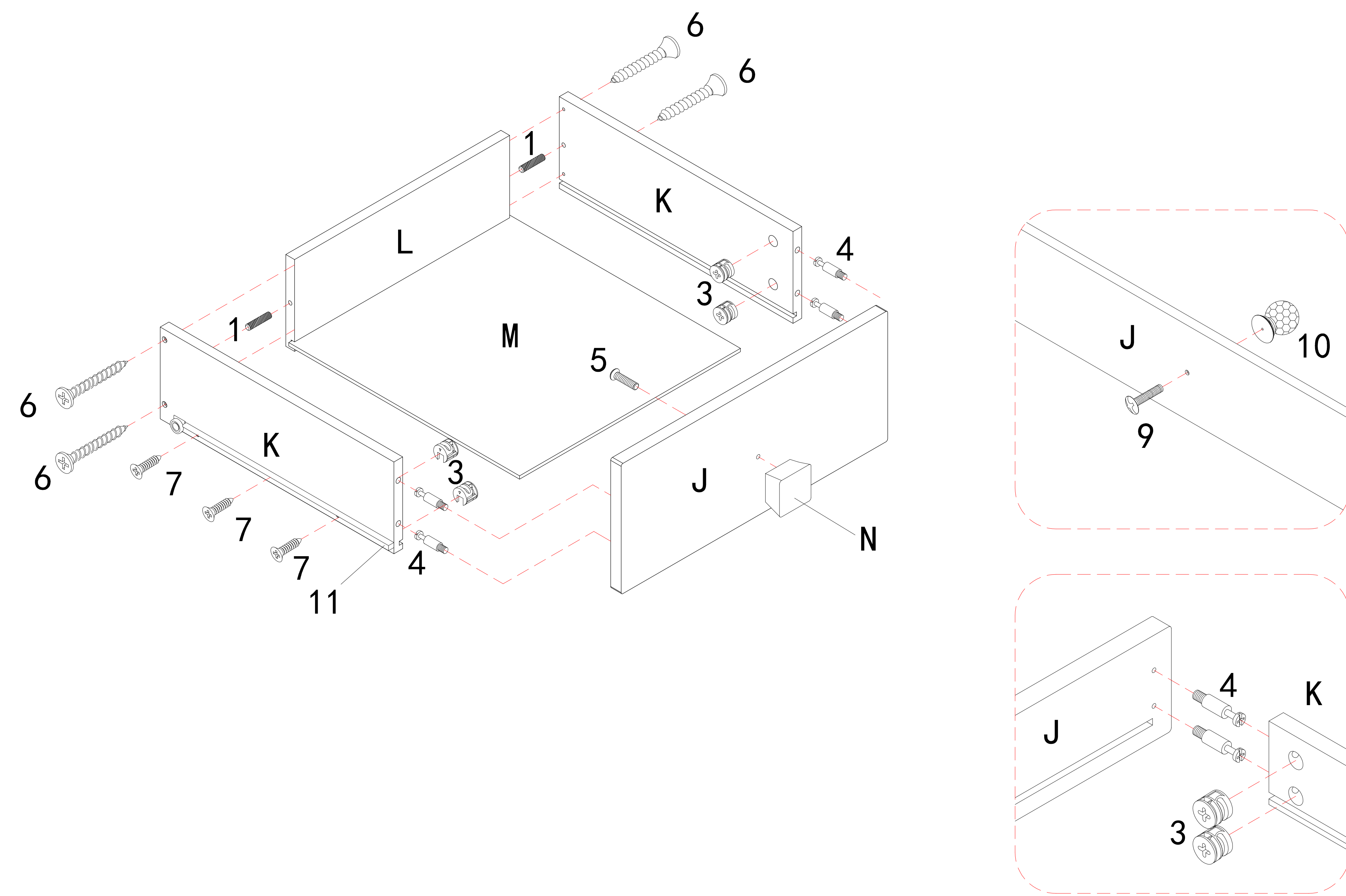

2

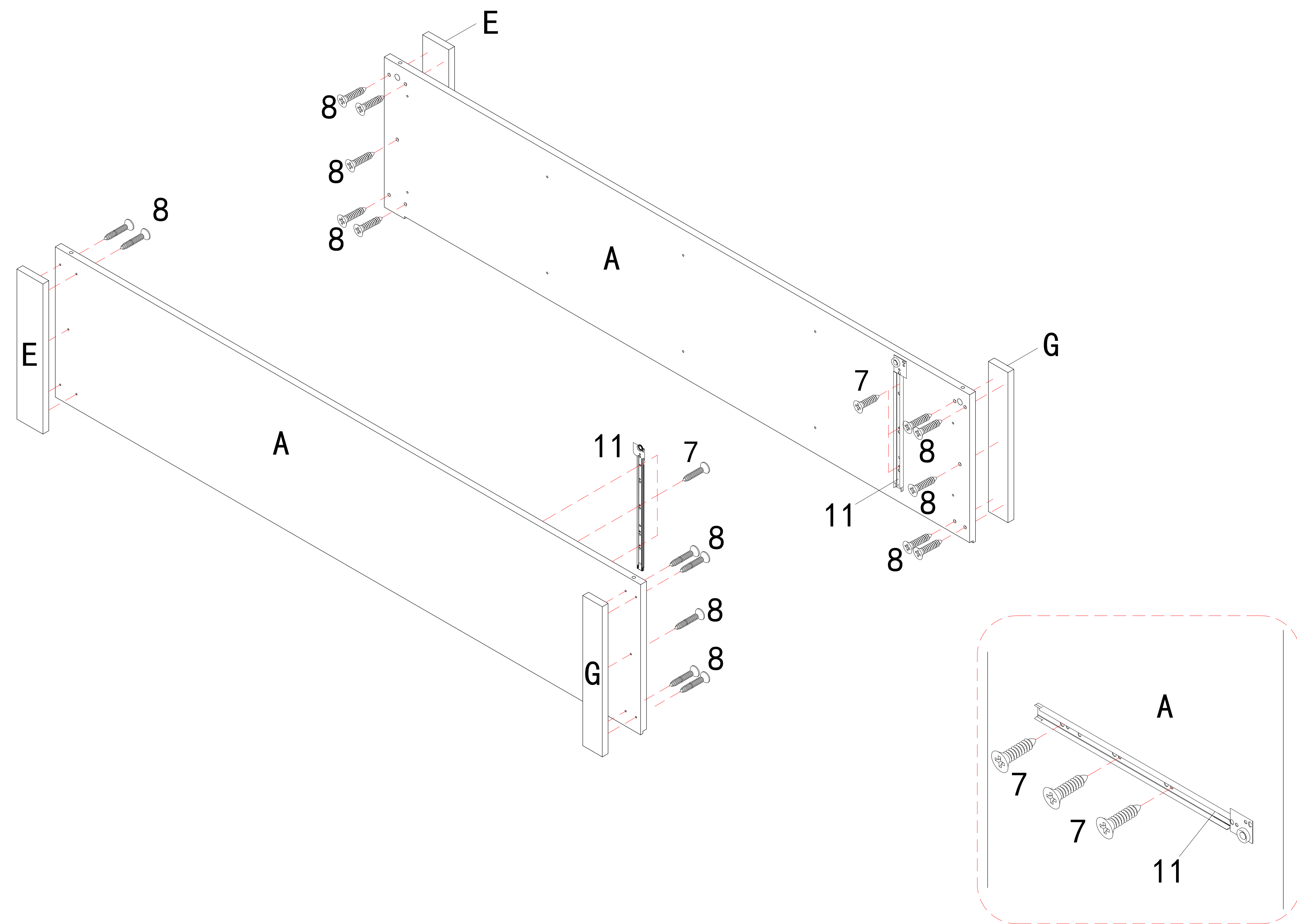

3

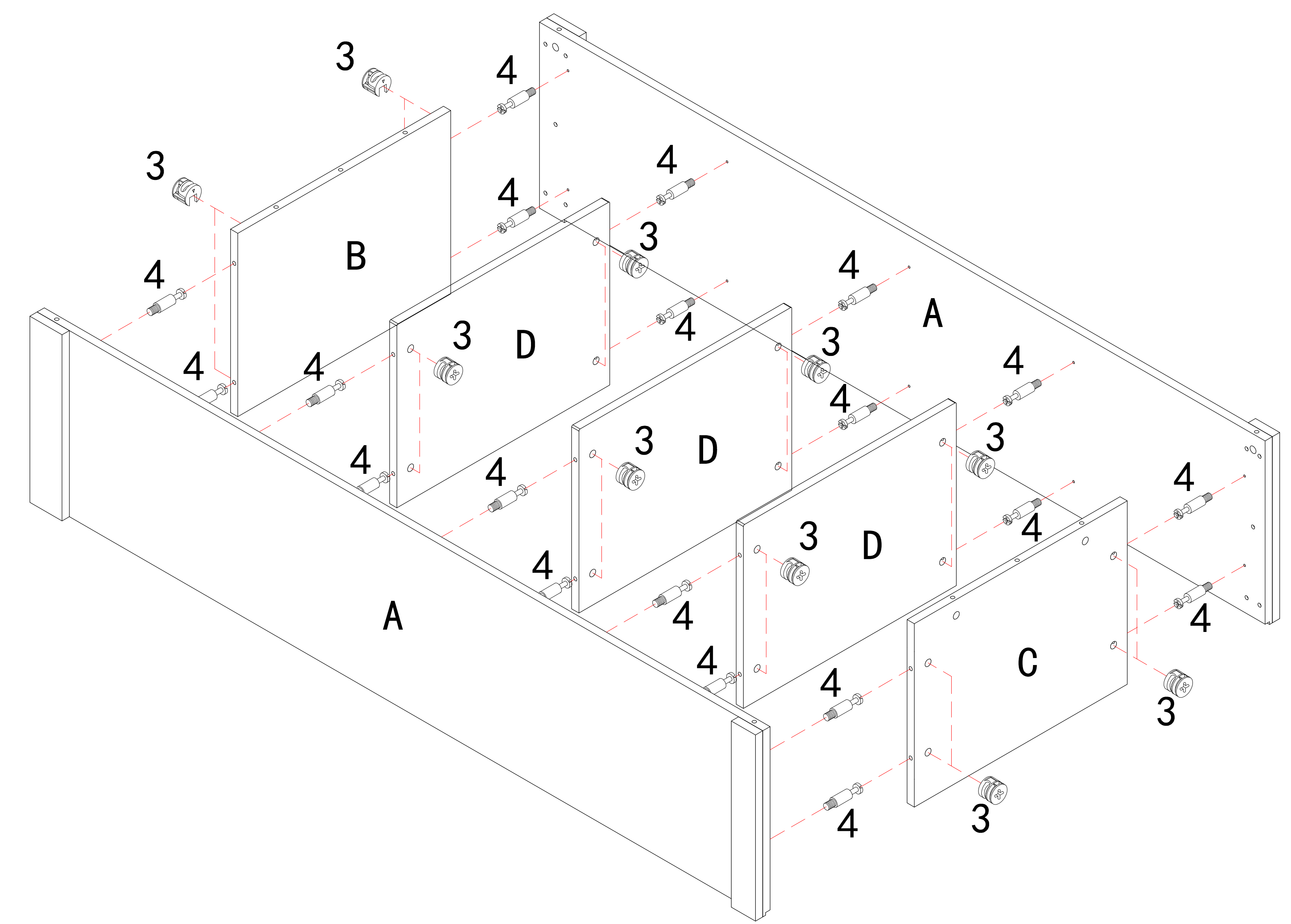

4

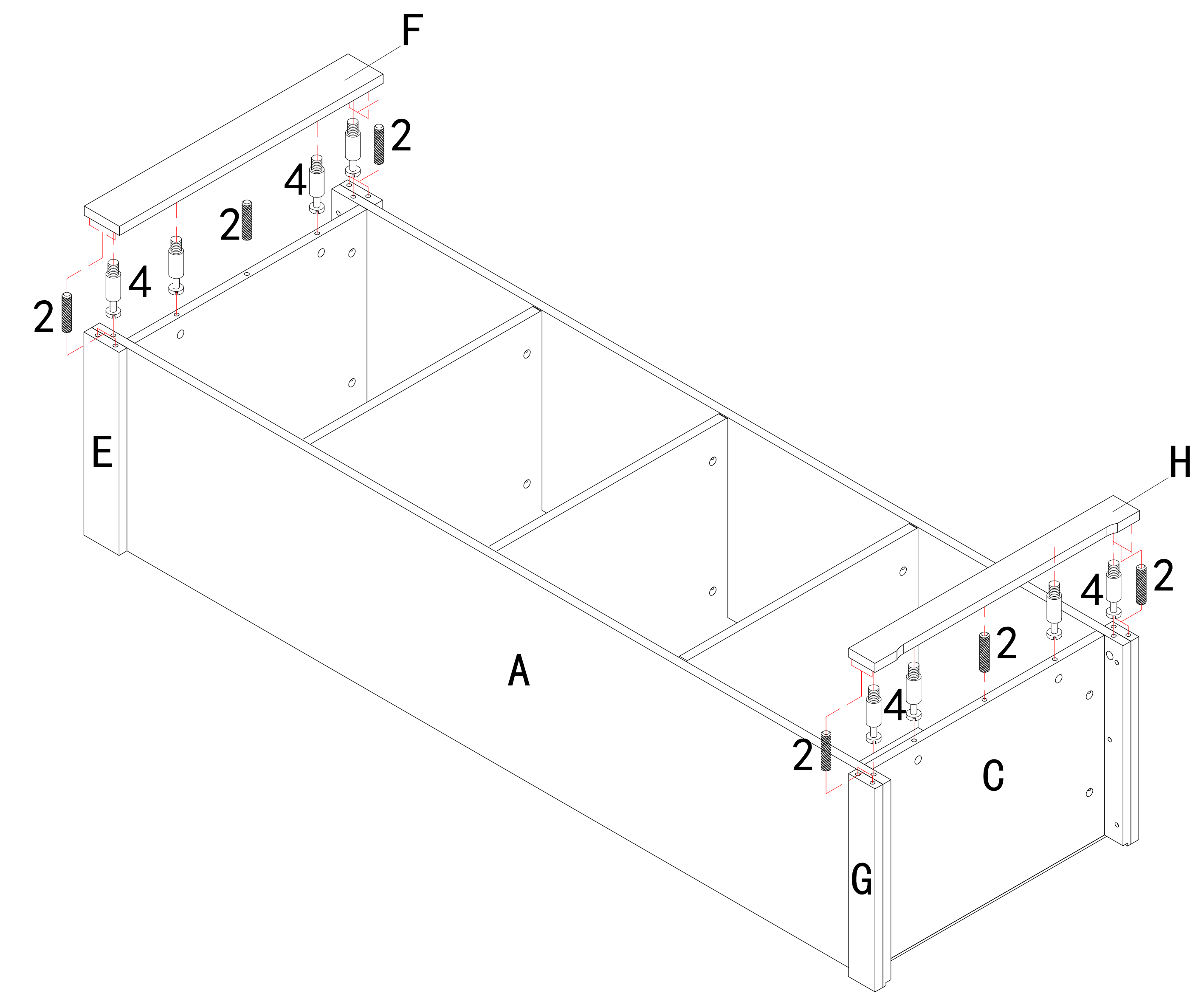

5

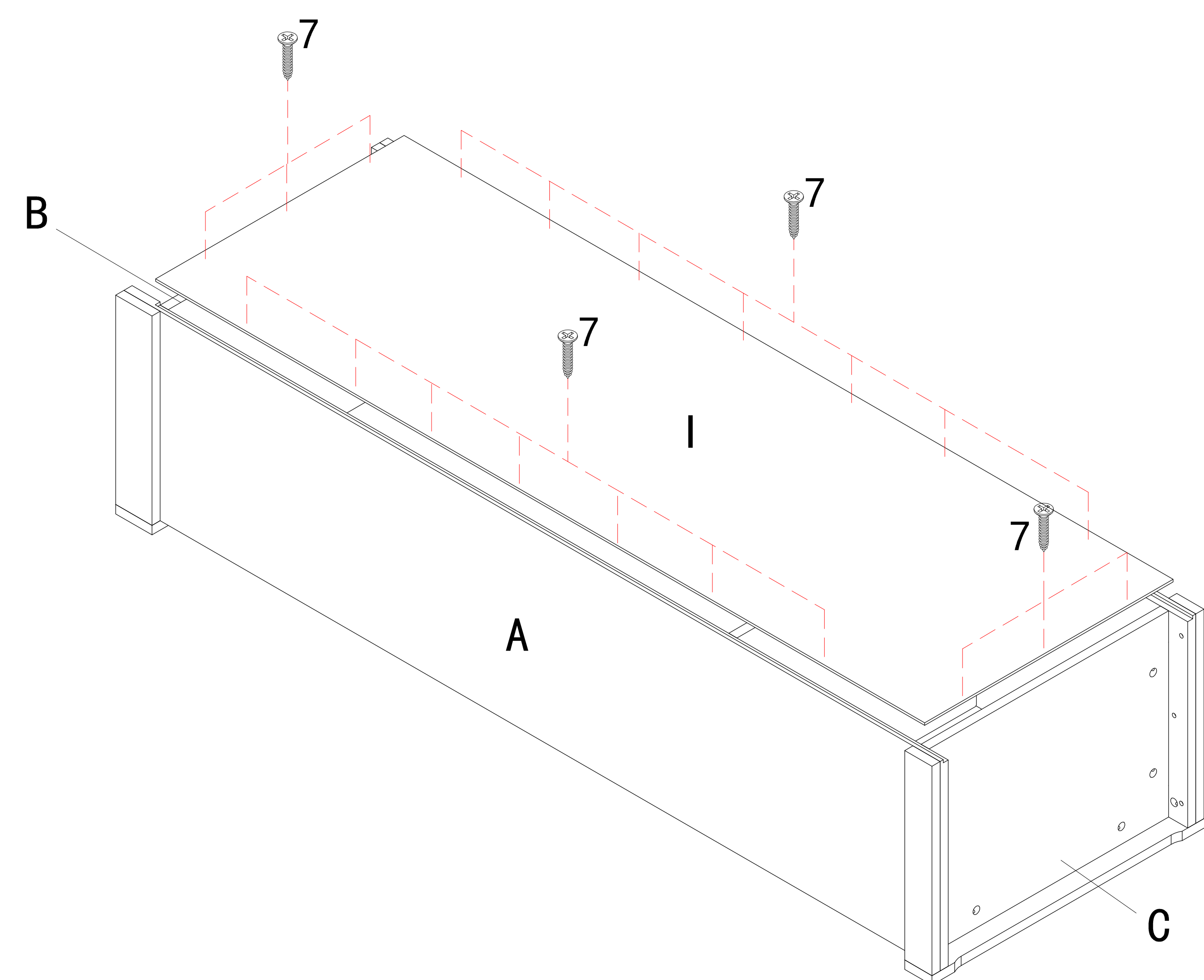

6

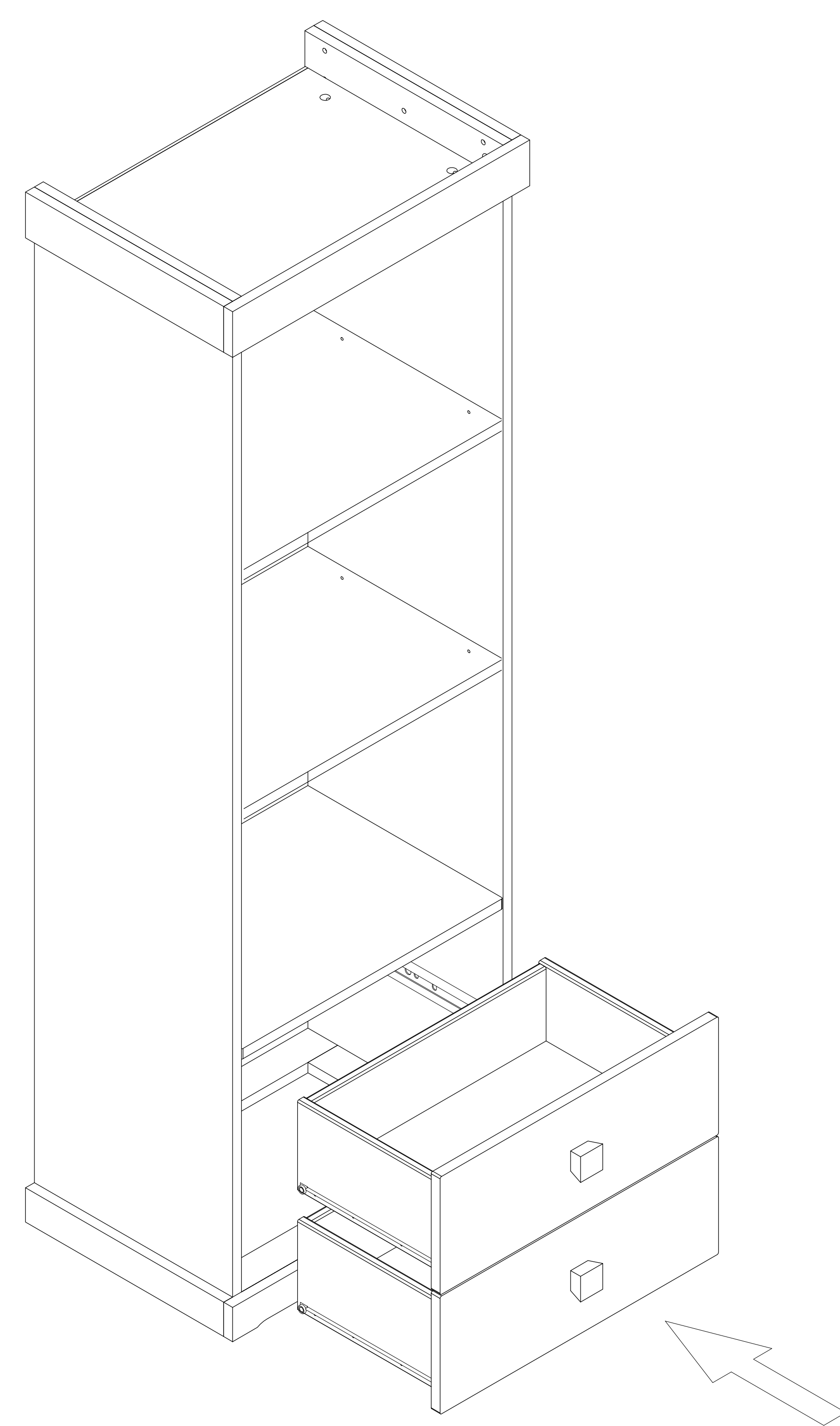

7

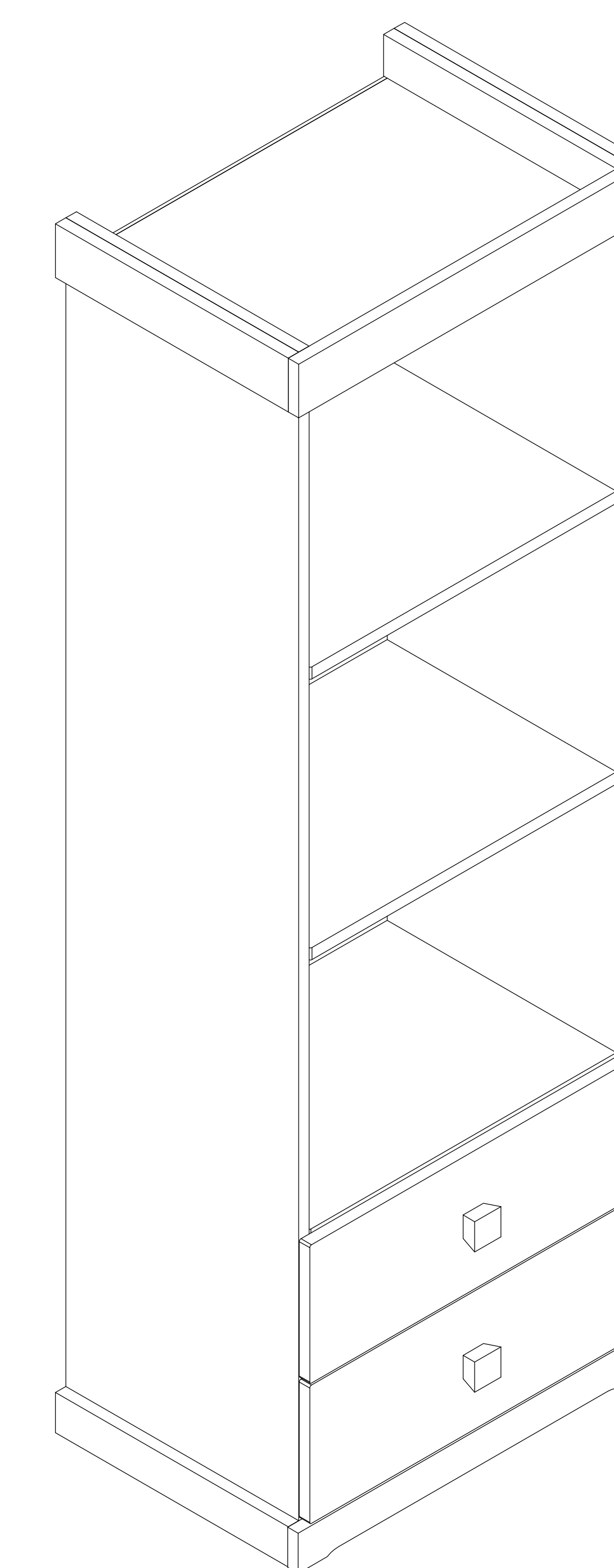

(FINISH)