





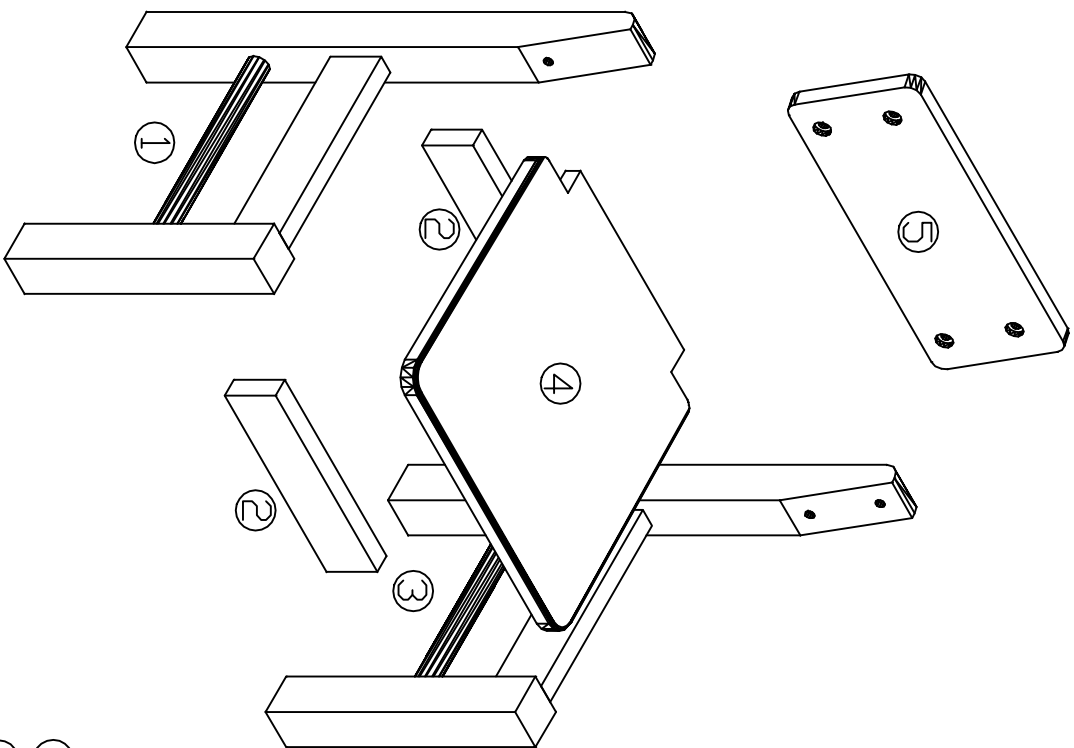

-  $\phi 5 \times 30$ 2PCS
-  $\phi 4 \times 50$ 4PCS
-  $\phi 8 \times 40$ 4PCS
-  M6x14 4PCS
-  $\phi 6 \times 7.5$ 4PCS
-  $\phi 4$ 1PC



- ①=1
- ②=2
- ③=1
- ④=1
- ⑤=1